

# ΣΥΣΤΗΜΑΤΑ ΚΑΓΚΕΛΟΥ

## RAILING SYSTEMS





ERAM

# ΓΙΑ ΤΗΝ ETEM

Η **ETEM** είναι μία πρωτοπόρος εταιρεία διέλασης αλουμινίου που κατατάσσεται μεταξύ των πιο πολλά υποσχόμενων στη Νοτιοανατολική Ευρώπη.

Η **ETEM** ιδρύθηκε το 1971 και δραστηριοποιείται στην παραγωγή ολοκληρωμένων αρχιτεκτονικών συστημάτων και προφίλ αλουμινίου για βιομηχανικές εφαρμογές υψηλής ποιότητας κι αισθητικής. Από την ίδρυσή της και την καθιέρωσή της ως την εταιρεία που ξεκίνησε την παραγωγή προφίλ αλουμινίου στην Ελλάδα, η **ETEM** αποτελεί πλέον την ειδικό στο σχεδιασμό, την ανάπτυξη και την παραγωγή ολοκληρωμένων συστημάτων αλουμινίου.

## ■ ΑΡΧΙΤΕΚΤΟΝΙΚΑ ΠΡΟΦΙΛ ΑΛΟΥΜΙΝΙΟΥ

- Συστήματα για πόρτες και παράθυρα
- Υαλοπετάσματα
- Συστήματα σκίασης
- Βάσεις αλουμινίου για Φωτοβολταικά συστήματα
- Εσωτερικά χωρίσματα
- Συστήματα αεριζόμενων προσόψεων
- Ανοδιωμένο σύστημα καγκέλου
- Σίτες

## ■ ΠΑΝΕΛ ΑΛΟΥΜΙΝΙΟΥ ΓΙΑ ΠΟΡΤΕΣ

## ■ ΘΩΡΑΚΙΣΜΕΝΕΣ/ΠΟΡΤΕΣ ΑΣΦΑΛΕΙΑΣ

## ■ ΒΙΟΜΗΧΑΝΙΚΑ ΠΡΟΦΙΛ ΑΛΟΥΜΙΝΙΟΥ

## ■ ΠΡΟΦΙΛ ΑΛΟΥΜΙΝΙΟΥ ΓΙΑ ΤΗΝ ΑΥΤΟΚΙΝΗΤΟΒΙΟΜΗΧΑΝΙΑ

# ABOUT ETEM

**ETEM** is a leading aluminium extrusion company among the most promising ones in South Eastern Europe.

It was founded in 1971 and with over 45 years of experience,

**ETEM** is a fully integrated designer and producer of architectural systems and aluminium profiles for industrial applications.

## ■ ALUMINIUM ARCHITECTURAL PROFILES

- Window and door systems
- Curtain wall systems
- Sun shading systems
- Solar systems
- Partition wall systems
- Ventilated façade systems
- Anodized railing system
- Insect screen systems

## ■ ALUMINIUM PANELS FOR DOORS

## ■ SECURITY/ARMORED DOORS

## ■ INDUSTRIAL ALUMINIUM PROFILES

## ■ ALUMINIUM PROFILES FOR AUTOMOTIVE INDUSTRY

# ΚΑΓΚΕΛΟ

ΜΕ ΟΡΙΖΟΝΤΙΑ ΣΤΟΙΧΕΙΑ

## RAILINGS

WITH HORIZONTAL PROFILES

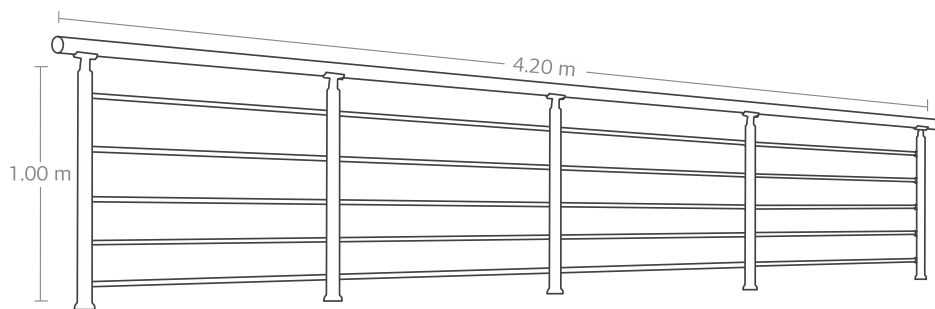

| ΠΡΟΦΙΛ<br>PROFILES | ΜΕΤΡΑ<br>METERS |
|--------------------|-----------------|
| ET832004.11        | 4.20            |
| ET832010.11        | 5.00            |
| ET832024.11        | 21.00           |
| ET832015.11        | 10.00           |

| ΕΞΑΡΤΗΜΑΤΑ<br>ACCESSORIES | ΤΕΜΑΧΙΑ<br>PIECES |
|---------------------------|-------------------|
| ET832151.11               | 5                 |
| ET832469.00               | 5                 |
| ET832101.11               | 5                 |
| ET832106.11               | 5                 |
| ET832354.11               | 25                |
| ET832214.00               | 2                 |
| ET832228.11               | 10                |

### ET832004.11

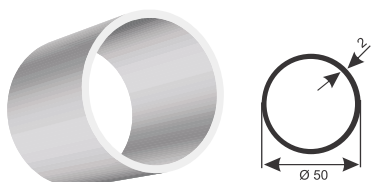

Κουραστή (50x2 mm) Ø50  
Upper profile (50x2,5 mm) Ø50

### ET832010.11

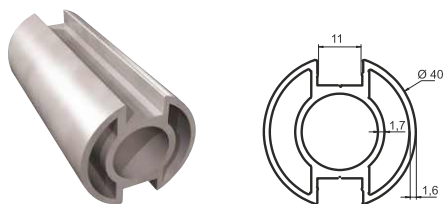

Κολώνα 2 καναλιών (40x1,6 mm) Ø40  
Strut with 2 channels (40x1,6 mm) Ø40

### ET832015.11



Κάλυμμα κολώνας Ø40  
Strut cover for strut Ø40

### ET832024.11

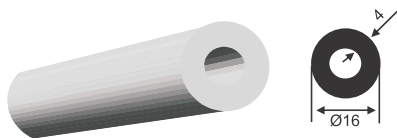

Δοκός (16x4 mm) Ø16  
Tube (16x4 mm) Ø16

### ET832214.11



Τάπα κουραστής Ø50  
Cap for upper profile Ø50

### ET832228.11



Τάπα δοκού (16x4 mm) Ø16  
Cap for tube (16x4 mm) Ø16





**ET832276.11**

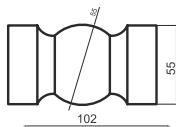

Ρυθμιζόμενη σύνδεση για κουραστή Ø50  
Adjustable support for upper profile Ø50

**ET832275.11**

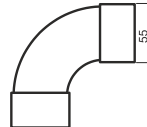

90° Γωνιακή σύνδεση για κουραστή Ø50  
Connection fitting 90° for upper profile (fixed) Ø50

**ET832279.11**

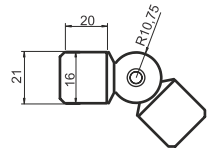

Ρυθμιζόμενη σύνδεση για δικό Ø16  
Adjustable bracket for tube Ø16

**ET832354.11**

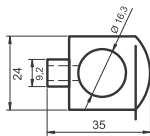

Υποδοχή ασφαλείας δοκού Ø16  
Support for tube (in the channel) Ø16

**ET832108.11**

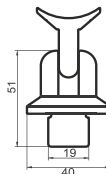

Υποστήριγμα κουραστής μεταβλητής γωνίας Ø50  
Adjustable upper profile support Ø50

**ET832280.11**

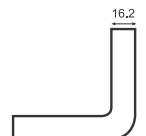

90° Γωνιακή σύνδεση για δοκό Ø16  
Support for tube (in the canal) Ø16

# ΚΑΓΚΕΛΟ

ΜΕ ΚΑΘΕΤΑ ΣΤΟΙΧΕΙΑ

## RAILINGS

WITH VERTICAL PROFILES

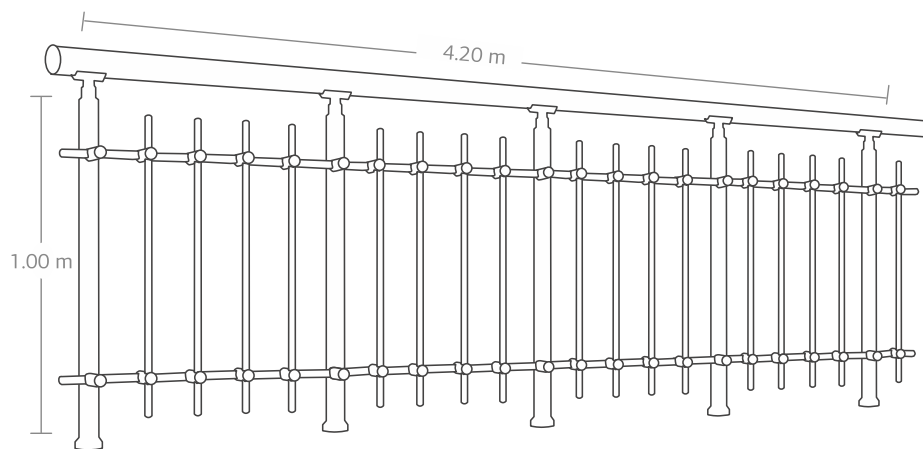

| ΠΡΟΦΙΛ<br>PROFILES | ΜΕΤΡΑ<br>METERS |
|--------------------|-----------------|
| ET832004.11        | 4.20            |
| ET832010.11        | 5.00            |
| ET832015.11        | 10.00           |
| ET832022.11        | 30.80           |

| ΕΞΑΡΤΗΜΑΤΑ<br>ACCESSORIES | ΤΕΜΑΧΙΑ<br>PIECES |
|---------------------------|-------------------|
| ET832101.11               | 5                 |
| ET832106.11               | 5                 |
| ET832469.11               | 5                 |
| ET832151.11               | 5                 |
| ET832214.11               | 2                 |
| ET832230.11               | 60                |
| ET832354.11               | 10                |
| ET832386.11               | 56                |

### ET832004.11



Κουραστή (50x2 mm) Ø50  
Upper profile (50x2 mm) Ø50

### ET832012.11

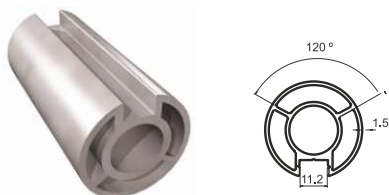

Κολώνα με 1 κανάλι Ø40  
Strut with 1 channel (40x1,5 mm) Ø40

### ET832015.11



Κάλυμμα κολώνας Ø40  
Strut cover for strut Ø40

### ET832022.11

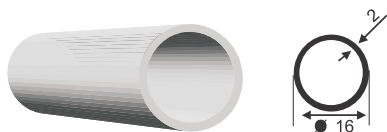

Δοκός (16x2 mm) Ø16  
Tube (16x2 mm) Ø16

### ET832214.11



Τάπα κουραστής Ø50  
Cap for upper profile Ø50

### ET832230.11



Τάπα δοκού (16x2 mm) Ø16  
Cap for tube (16x2 mm) Ø16



**ET832379.11**

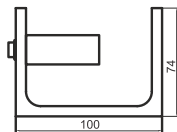

Εξωτερική στήριξη κολώνας Ø40  
Strut support - external Ø40

**ET832355.11**

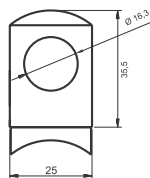

Υποδοχή ασφαλείας δοκού Ø16  
Support for tube Ø16

**ET832354.11**

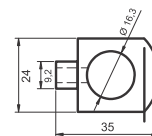

Υποδοχή ασφαλείας δοκού Ø16  
Support for tube (in the channel) Ø16

**ET832154.11**

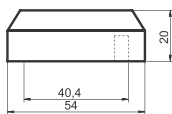

Φλάντζα κολώνας με 1 κανάλι Ø40  
Flange for strut (with 2 teeth) Ø40

**ET832386.11**

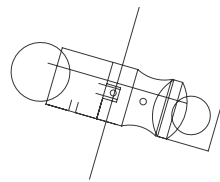

Σύνδεσμος δοκών Ø16  
Connection fitting for profiles Ø16xØ16

**ET832108.11**

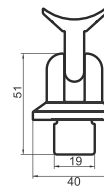

Υποστήριγμα κουραστικής μεταβλητής γωνίας Ø50  
Adjustable upper profile support Ø50

# ΚΑΓΚΕΛΟ ΜΕ ΤΖΑΜΙ

## RAILINGS WITH GLASS

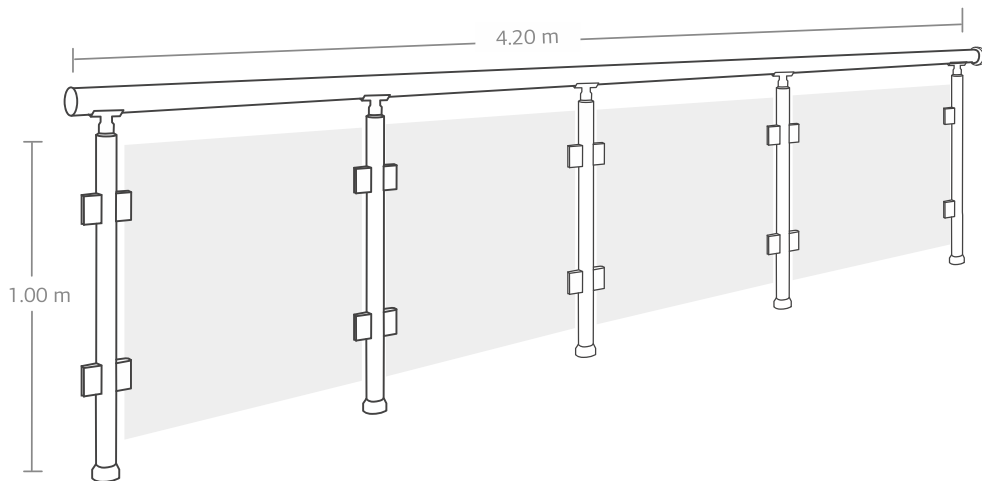

| ΠΡΟΦΙΛ<br>PROFILES | ΜΕΤΡΑ<br>METERS |
|--------------------|-----------------|
| ET832004.11        | 4.20            |
| ET832010.11        | 5.00            |
| ET832015.11        | 10.00           |

| ΕΞΑΡΤΗΜΑΤΑ<br>ACCESSORIES | ΤΕΜΑΧΙΑ<br>PIECES |
|---------------------------|-------------------|
| ET832101.11               | 5                 |
| ET832106.11               | 5                 |
| ET832469.11               | 5                 |
| ET832151.11               | 5                 |
| ET832214.11               | 2                 |
| ET832420.11               | 16                |

### ET832004.11



Κουραστή (50x2 mm) Ø50  
Upper profile (50x2 mm) Ø50

### ET832010.11

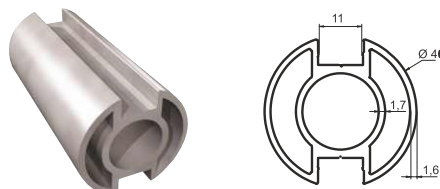

Κολώνα 2 καναλιών (40x1,6 mm) Ø40  
Strut with 2 channels (40x1,6 mm) Ø40

### ET832015.11



Κάλυμμα κολώνας Ø40  
Strut cover for strut Ø40

### ET832267.11

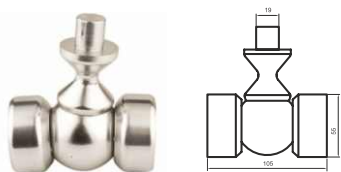

Ρυθμιζόμενος γωνιακός σύνδεσμος κουραστής Ø50  
Adjustable support for upper profile (for corner strut) Ø50

### ET832164.11

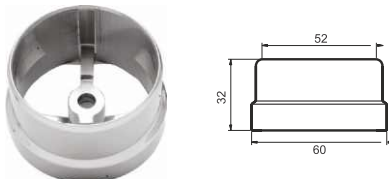

Επιτοίχια φλάντζα κουραστής Ø50  
Wall flange Ø50

### ET832214.11



Τάπα κουραστής Ø50  
Cap for upper profile Ø50



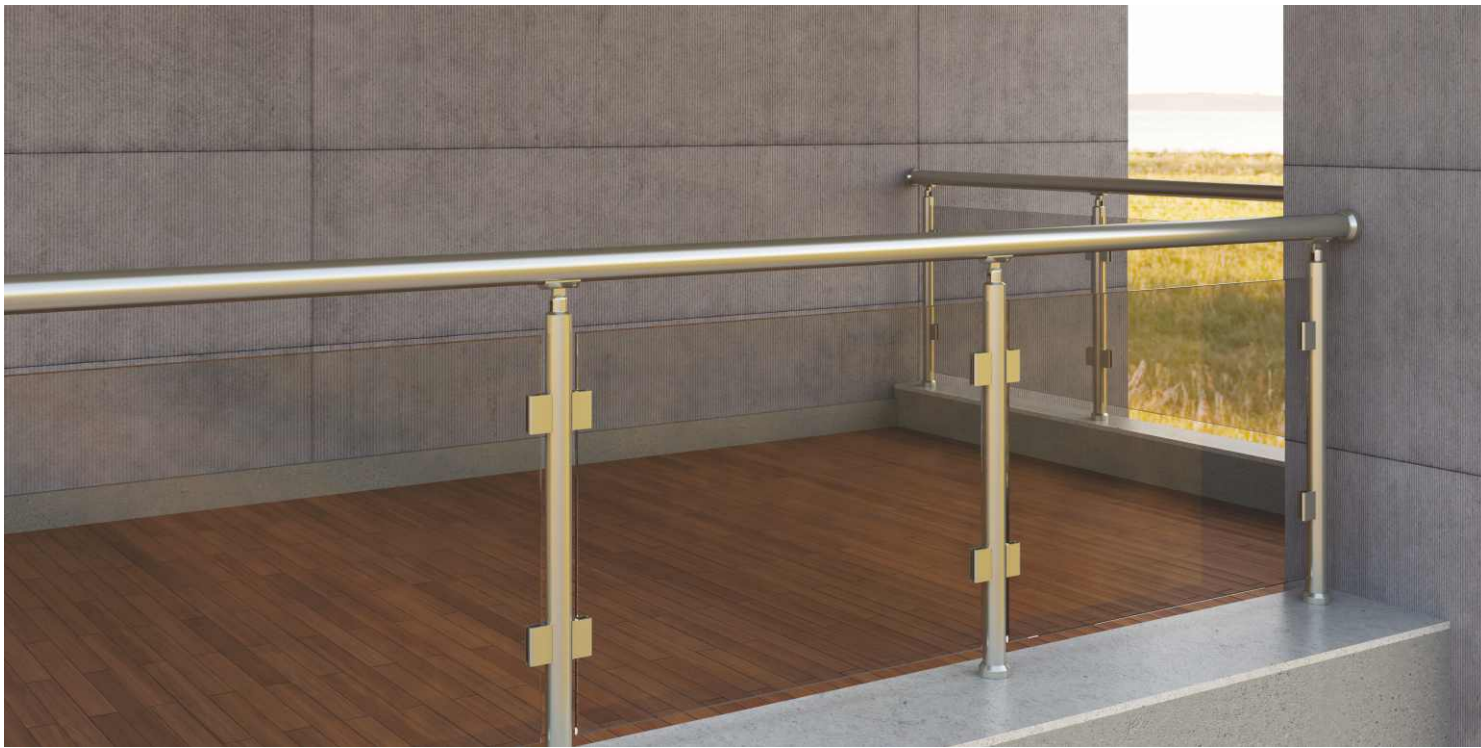

**ET832151.11**

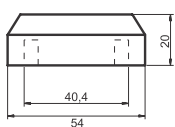

Φλάντζα κολώνας Ø40  
Flange for strut (with 2 teeth) Ø40

**ET832420.11**

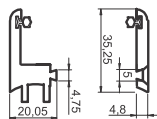

Διαίρουμενη υποδοχή γυαλιού (με λάστιχο)  
Demountable glass support (with gasket)

**ET832108.11**

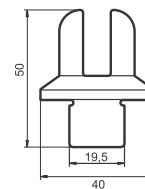

Εξάρτημα συγκράτησης κουπαστής Ø50  
Adjustable upper profile support Ø50

**ET832432.11**

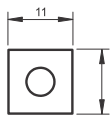

Συγκρατητής γυαλιού  
Glass stopper

**ET832430.11**

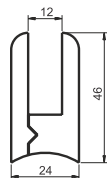

Υποδοχή γυαλιού με λάστιχο (εξωτερικά της κολώνας)  
Glass support for round typology (externally from the strut)

# ΚΟΥΠΑΣΤΗ

## RAILING HANDLES



ET832166.11



Εύκαμπτη φλάντζα κουραστής Ø50  
Adjustable wall flange Ø50

ET832004.11



Κουραστή (50x2 mm) Ø50  
Upper profile (50x2 mm) Ø50

ET832170.11

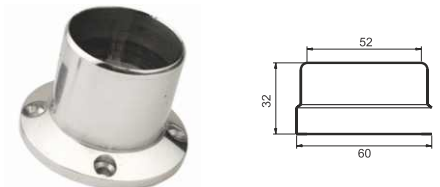

Πέλαμα στήριξης για κουραστή Ø50  
Support flange for profile Ø50

ET832380.11

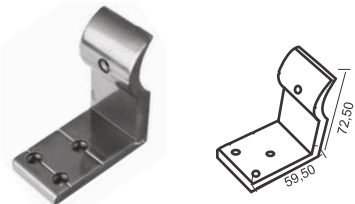

Σύνδεση τοίχου κουραστής Ø40  
Wall support L type

ET832174.11



Δακτύλιος κάλυψης πέλματος στήριξης για κολώνα Ø40  
Cover ring for support flange Ø40

ET832214.11



Τάπα κουραστής Ø50  
Cap for upper profile Ø50

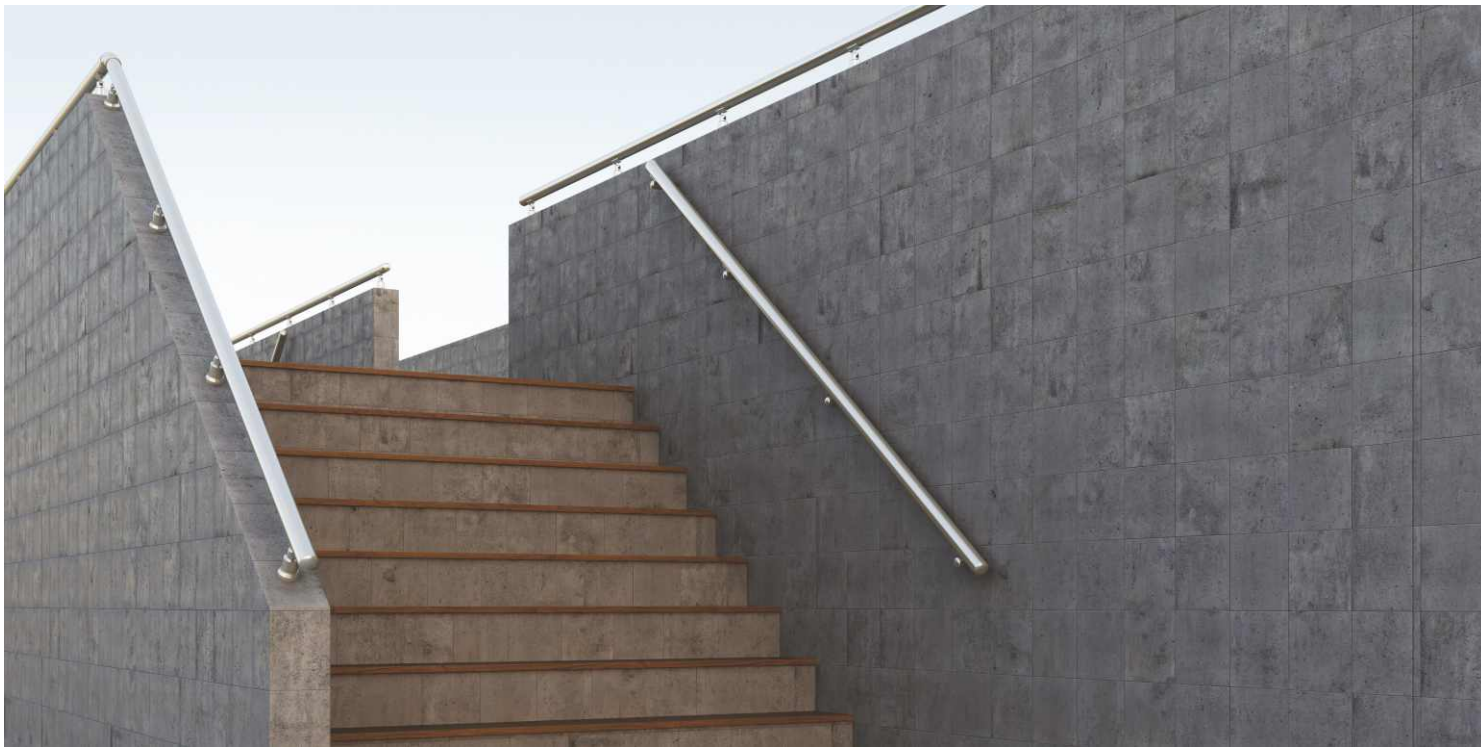

**ET832315.11**

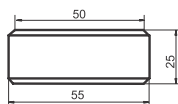

Δάκτυλος για κουραστή Ø50  
Connection ring for upper profile (collar) Ø50

**ET832469.00**



Μεταλλικό αγκύριο κολώνας  
Steel anchor

**ET832388.11**

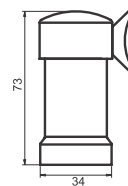

Επιτοίχια στήριξη κουραστής  
Wall support for upper profile Ø50

**ET832164.11**

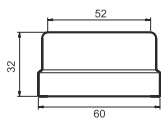

Επιτοίχια φλάντζα κουραστής Ø50  
Wall flange Ø50

**ET832276.11**

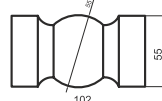

Ρυθμιζόμενη σύνδεση για κουραστή Ø50  
Adjustable support for upper profile Ø50

**ET832175.11**

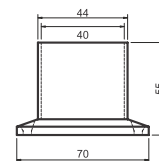

Πέλμα στήριξης για κολώνα Ø40  
Support flange for profile Ø40

# ΚΑΓΚΕΛΟ ΕΣΩΤΕΡΙΚΟΥ ΧΩΡΟΥ

## INDOOR RAILINGS

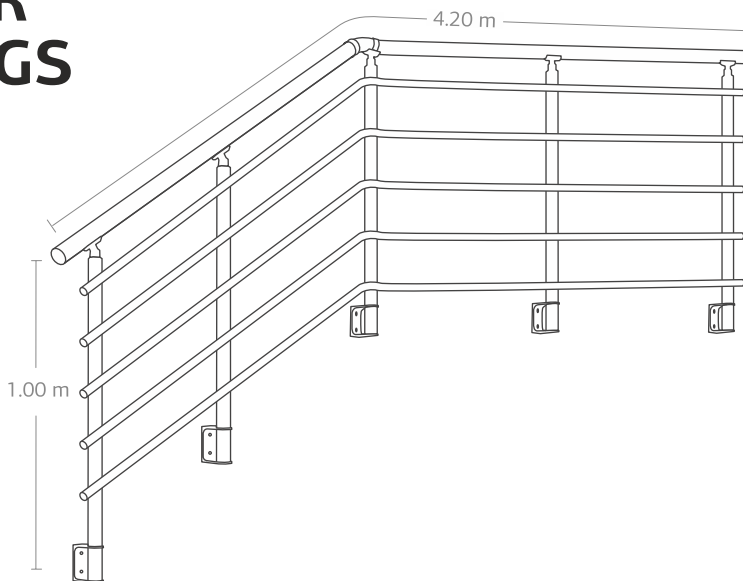

### ΠΡΟΦΙΛ PROFILES

### ΜΕΤΡΑ METERS

|             |       |
|-------------|-------|
| ET832004.11 | 4.20  |
| ET832010.11 | 5.00  |
| ET832015.11 | 10.00 |
| ET832022.11 | 21.00 |

### ΕΞΑΡΤΗΜΑΤΑ ACCESSORIES

### ΤΕΜΑΧΙΑ PIECES

|             |    |
|-------------|----|
| ET832101.11 | 5  |
| ET832106.11 | 5  |
| ET832379.11 | 5  |
| ET832214.11 | 1  |
| ET832230.11 | 10 |
| ET832276.11 | 1  |
| ET832279.11 | 5  |
| ET832354.11 | 25 |
| ET832164.11 | 1  |

#### ET832004.11



Κουραστή (50x2 mm) Ø50  
Upper profile (50x2 mm) Ø50

#### ET832010.11

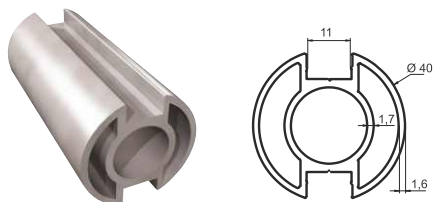

Κολώνα 2 καναλιών (40x1,6 mm) Ø40  
Strut with 2 canals (40x1,6 mm) Ø40

#### ET832015.11



Κάλυμμα κολώνας Ø40  
Strut cover for strut Ø40

#### ET832022.11

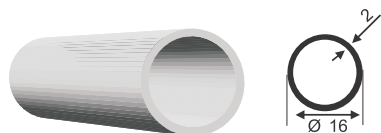

Δοκός (16x2 mm) Ø16  
Tube (16x2 mm) Ø16

#### ET832214.11



Τάπα κουραστής Ø50  
Cap for upper profile Ø50

#### ET832230.11



Τάπα δοκού Ø16  
Cap for tube (16x2 mm) Ø16





**ET832379.11**

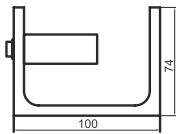

Εξωτερική στήριξη κολώνας Ø40  
Strut support (external) Ø40

**ET832277.11**

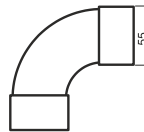

90° Γωνία συνδέσεως για κουπαστή Ø50  
Connection fitting 90° for upper profile (fixed) Ø50

**ET832108.11**

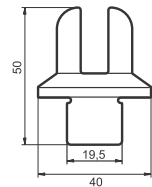

Εξάρτημα συγκράτησης κουπαστής Ø50  
Adjustable upper profile support Ø50

**ET832151.11**

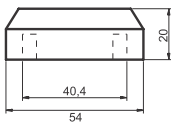

Φλάντζα κολώνας Ø40  
Flange for strut (with 2 teeth) Ø40

**ET832354.11**

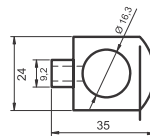

Υποδοχή ασφαλείας δοκού Ø16  
Support for tube (in the channel) Ø16



# ΚΑΓΚΕΛΟ ΕΞΩΤΕΡΙΚΟΥ ΧΩΡΟΥ

## OUTDOOR RAILINGS



ET832004.11

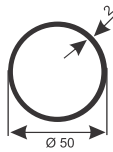

Κουραστί (50x2 mm) Ø50  
Upper profile (50x2 mm) Ø50

ET832010.11

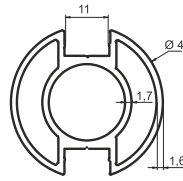

Κολώνα 2 καναλιών Ø40  
Strut with 2 channels (40x1,6 mm) Ø40

ET832315.11

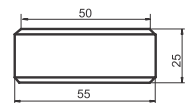

Δακτύλιος για κουραστί Ø50  
Connection ring for upper profile (collar) Ø50

ET832164.11

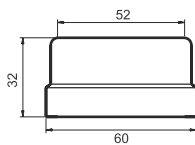

Επιτοίχια φλάντζα κουραστίς Ø50  
Wall flange Ø50

ET832354.11

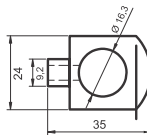

Υποδοχή ασφαλείας δοκού Ø16  
Support for tube (in the canal) Ø16

ET832174.11

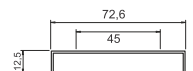

Δακτύλιος κάλυψης πέλατος στήριξης για κολώνα Ø40  
Cover ring for support flange Ø40



**ET832281.11**



45° Γωνιακή σύνδεση για δοκό Ø16  
Connection fitting 45° for tube (fixed) Ø16

**ET832280.11**



90° Γωνιακή σύνδεση για δοκό Ø16  
Connection fitting 90° for tube (fixed) Ø16

**ET832175.11**

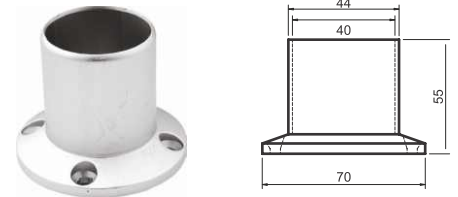

Πέλαμα στήριξης για κολώνα Ø40  
Support flange for profile Ø40

# ΠΡΟΣΘΕΤΑ ΕΞΑΡΤΗΜΑΤΑ

## ADDITIONAL ACCESSORIES

### ET832378.11



Σύνδεση κολώνας με κολώνα  $\varnothing 40 \times \varnothing 40$   
Connection fitting for profiles  $\varnothing 40 \times \varnothing 40$

### ET832377.11



Σύνδεση κολώνας με σωλήνα  $\varnothing 40 \times \varnothing 50$   
Connection fitting for profiles  $\varnothing 40 \times \varnothing 50$

### ET832104.11



Σταθερό υποστήριγμα κουπαστής  $\varnothing 50$   
Fixed upper profile support  $\varnothing 50$

### ET832161.11



Φλάντζα τοίχου για  $\varnothing 16$   
Wall flange  $\varnothing 16$

### ET832162.11



Φλάντζα τοίχου για  $\varnothing 16$   
Wall flange (with screw)  $\varnothing 16$

### ET832353.11

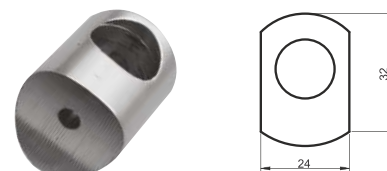

Υποστήριγμα συγκράτησης δοκού για κολώνα με 1 κανάλι  $\varnothing 16$   
Support for tube  $\varnothing 16$

**ET832014.11**

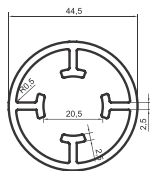

Κολώνα χωρίς κανάλι Ø40  
Strut without channel (40x1,5 mm) Ø40

**ET832153.11**

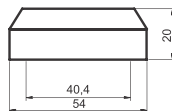

Φλάντζα δαπέδου κολώνας χωρίς κανάλι Ø40  
Flange for strut (no teeth) Ø40

**ET832501.11**



Σύρτης  
Bolt for railing doors

**ET832500.11**



Μεντεσές  
Hinge for railing doors







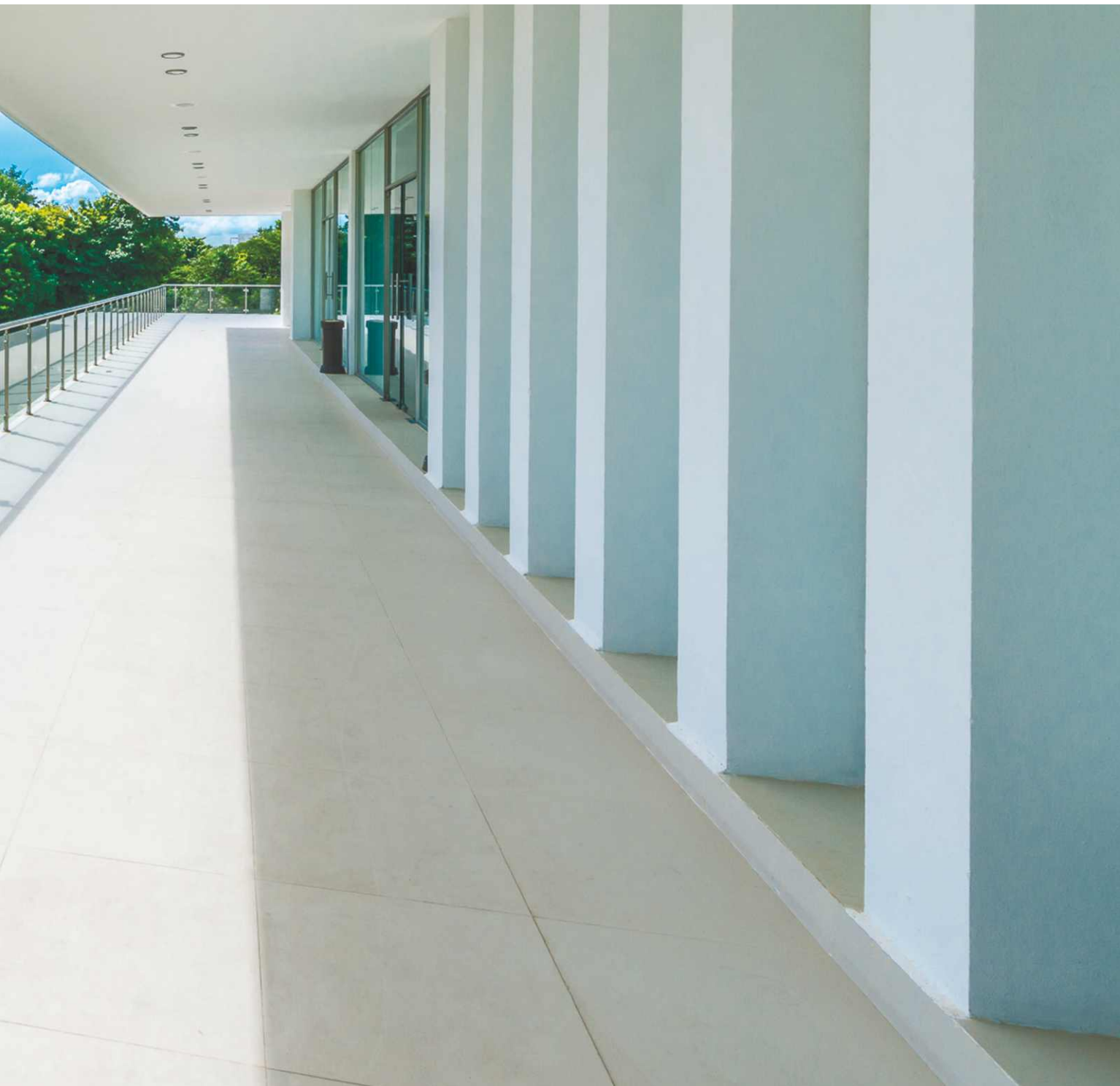

etem.com